



Series 20/30 Boosters T Series Air/Oil Tanks



HYDRO-LINE, INC.

An IMC Company



Table of Contents

Booster Design Featurespage 2
Booster Designspages 3-4
What is a Booster?page 5
How to Select a Boosterpage 6
Booster Selection Chart.....page 7

How to Order a Boosterpage 8
Booster Application Data Sheetpage 9
Booster Mounting Dimensionspages 10-11
Air/Oil Tanks.....page 12
How to Order/Select a Tank.....page 13

Booster Design Features

Specifications

Bore Sizes: 3/4" through 14"
Pressure Rating: 5000 psi
Temperature: -40°F to 200°F standard

Series 20 and Series 30 Boosters incorporate PolyPak ram seals, nitrile lip-type piston seals, .0003/.0005" thick chrome plated tube I.D. and NPTF ports.

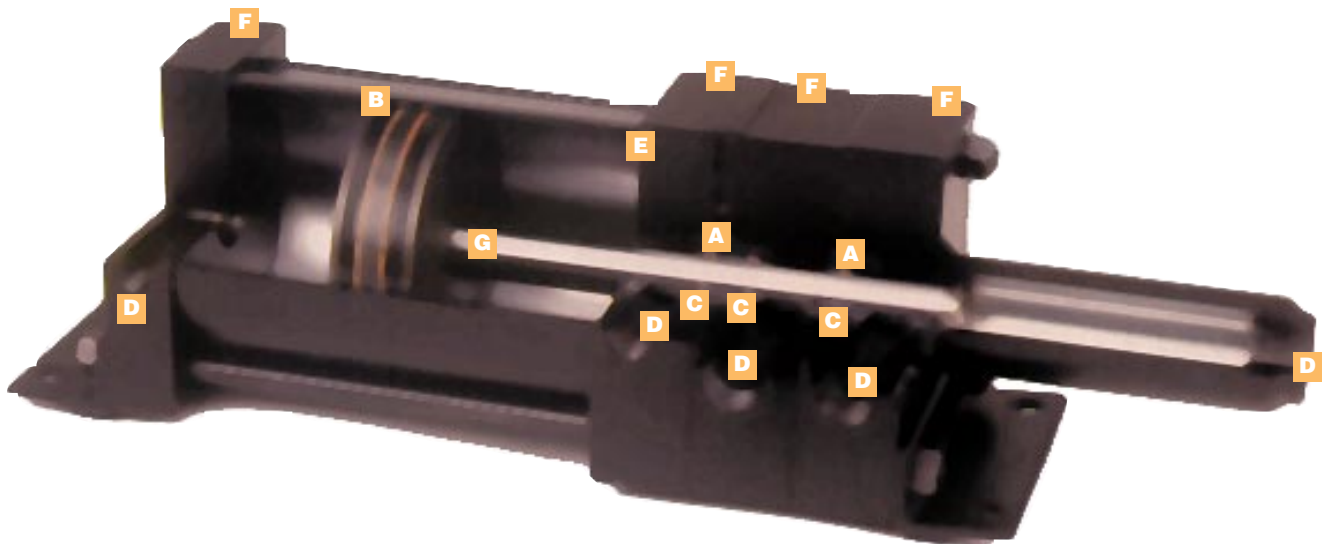

A Heavy Duty Ram Cartridge

- Machined from gray iron for maximum bearing support and wear resistance
- Unitized, threadless assembly is pilot fitted into the head on a precision bored diameter to assure true concentricity

B Piston Seals

- Nitrile lip-type seals are standard
- Special seals are available

C Ram Seals

- PolyPak ram seals are standard
- Special seals are available

D Ports

- NPTF ports are standard; SAE ports are available at no extra charge

E Teflon Tube Seals

- Superior design to prevent leakage
- Compatible with virtually all fluids
- Operating temperatures to 500°F

F Precision Steel Heads and Caps

- Provides truly flat and parallel mounting surfaces
- Insures correct alignment of tube and ram cartridge

G Wear Resistant High-Pressure Ram

- 5/8" through 3" diameter rams are case hardened and hard chrome plated
- All rams polished to 8-14 micro inch finish for long seal life
- 17-4 PH stainless steel and other materials also available

Hydro-Line Series 20 Boosters

Output Pressures to 5000 psi

Hydro-Line Series 20 boosters consist of a driving piston, a high-pressure ram and a high-pressure chamber. Prefilling the circuit and low-pressure advance of the work cylinder through the high-pressure booster chamber can be achieved through external valving.

Series 20 Booster Operation

1: With the booster driving piston fully retracted, low-pressure fluid may be applied to the circuit by an air-oil tank. This low pressure prefills the circuit and may advance a work cylinder through part of its stroke. If a reservoir or air-oil tank is in the circuit, a check valve in that line will prevent high-pressure fluid from dissipating into the air-oil tank.

2: The port in end cap B is open to exhaust. Applying air pressure to the port in end cap C drives the high-pressure ram into the high-pressure chamber. As the high-pressure ram advances, high-pressure fluid is discharged from either port of the high-pressure chamber. End cap A is part of the high-pressure chamber.

The work cylinder will stop when it meets a resistance greater than it can overcome. It will maintain force against the resistance indefinitely – without heat buildup or loss of energy – because no additional low-pressure fluid is consumed.

3: When the cylinder's work is completed, the high-pressure ram is retracted by applying pressure to the port in end cap B. The port in end cap C is open to exhaust. The work cylinder may be returned by an external force, by air pressure or by low-pressure fluid from an air-oil tank. The booster then is ready to be recycled.

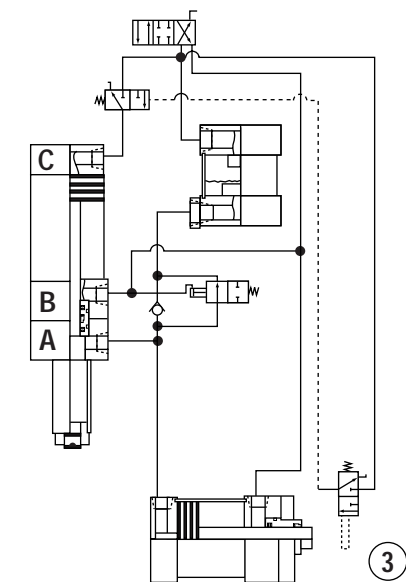
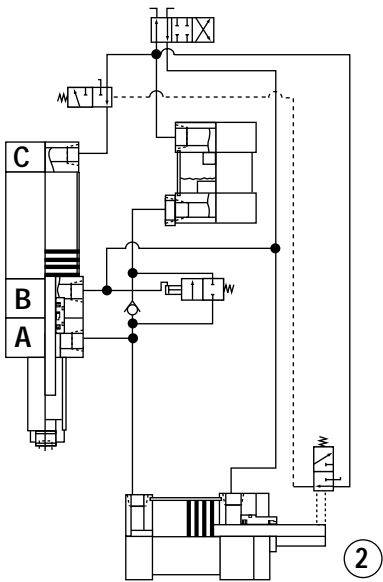
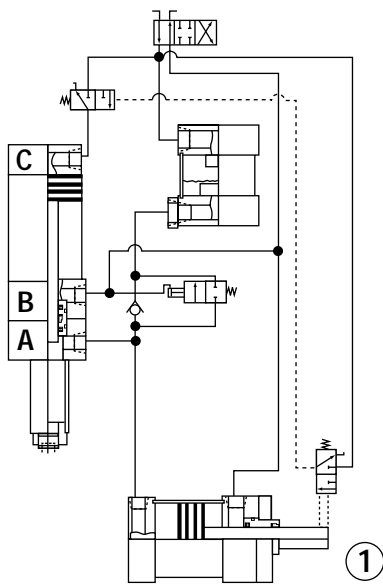

Accumulator Application of Series 20 Boosters

Series 20 boosters use shop air which eliminates the need for high-pressure nitrogen when used as accumulators in hydraulic power units. Self-relieving air pressure regulation of the input air eliminates change in accumulator output pressure as the position of the high-pressure ram changes. The entire ram stroke may be used with allowance to avoid bottoming in either direction.

Hydro-Line Series 30 Boosters

Single or integral dual pressure... self-bleeding... output pressures to 5000 psi.

Hydro-Line Series 30 boosters consist of a driving piston, a high-pressure ram and a high-pressure chamber. Prefilling the circuit and low-pressure advance of the work cylinder through the high-pressure booster chamber is achieved without check valves.

Self-Bleeding

When the booster is installed at a point higher than the work cylinder and the air-oil tank higher than the booster, any air in the work cylinder, booster high-pressure chamber or oil lines will move automatically to the air-oil tanks. From there, air will bleed into the atmosphere.

Dual-Pressure Operation Reduces Power Costs

Series 30 boosters require only a fraction of the air consumed in direct air cylinder actuation. If the booster ratio is 25:1, for example, only $\frac{1}{25}$ as much air is used per inch of low-pressure advance, compared to air consumed when high pressure is used throughout the entire stroke.

Series 30 Booster Operation

- 1: With the booster driving piston fully retracted, low-pressure fluid from an air-oil tank is applied to the port in end cap **B**. The circuit is then prefilled at low pressure. The low pressure also normally advances a work cylinder through part of its stroke.
- 2: The port in end cap **C** is open to exhaust. Applying air pressure to the port in end cap **D** drives the high-pressure ram past the high-pressure chamber seal, shutting off access to the air-oil tank. After the ram passes the seal, high-pressure fluid is discharged from either port of the high-pressure chamber. End cap **A** is part of the high-pressure chamber.

The work cylinder will stop when it meets a resistance greater than it can overcome. It will maintain force against the resistance indefinitely – without heat buildup or loss of energy – because no additional low-pressure fluid is consumed.

- 3: When the cylinder's work is completed, the high-pressure ram is retracted by applying pressure to the port in end cap **C**. The port in end cap **D** is open to exhaust. As the ram passes the booster chamber seal, fluid is allowed to return to the air-oil tank. The work cylinder may be returned by an external force, by air pressure or by low-pressure fluid from an air-oil tank. The booster then is ready to be recycled.

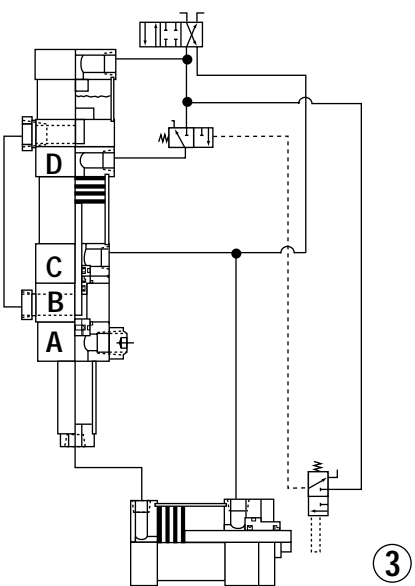
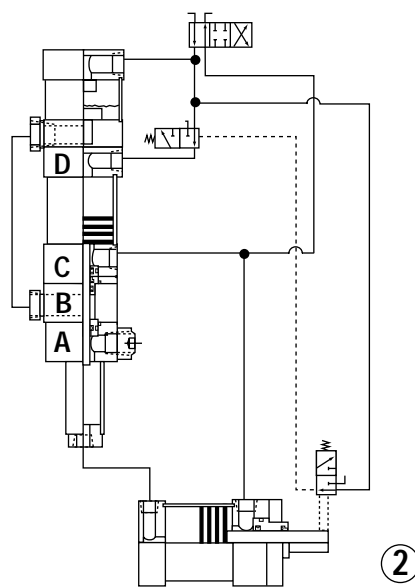
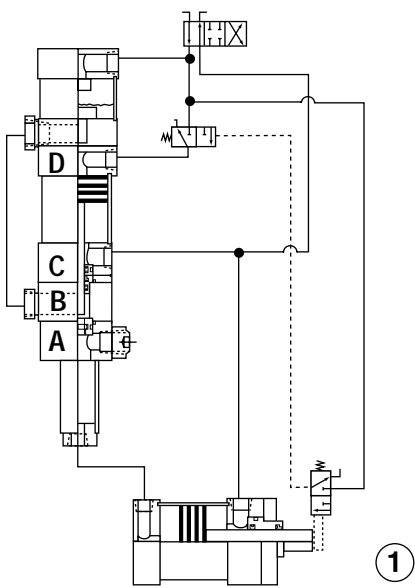

What is a Booster?

A booster is a fluid power component which utilizes a source of fluid under pressure to produce a higher pressure. The input and output fluid may be air, oil or water. The input fluid is usually air and the output fluid usually is oil.

Output pressure of a booster is proportional to the cross-sectional area of the driving piston divided by the cross-sectional area of the driven high-pressure ram (the booster's piston rod is, in effect, a hydraulic ram).

For example, if a piston has an area of 25 sq. in. and the high-pressure ram has an area of 1 sq. in., output pressure will be 25 times as great as the input pressure. Conversely, the volume of output oil will be $\frac{1}{25}$ that of input air.

Where are Boosters Used?

Hydro-Line boosters commonly are used in cylinder applications such as pressing, calendering, riveting, clamping, crimping, molding, welding, punching and hydrostatic testing. (See figures below.)

Boosters are not limited to cylinder applications and may be used wherever a small volume of high-pressure fluid is required.

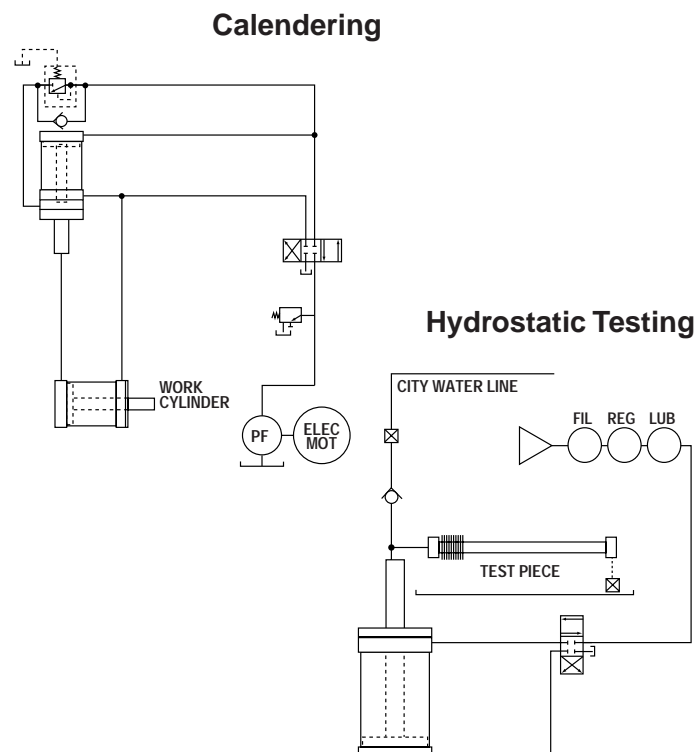
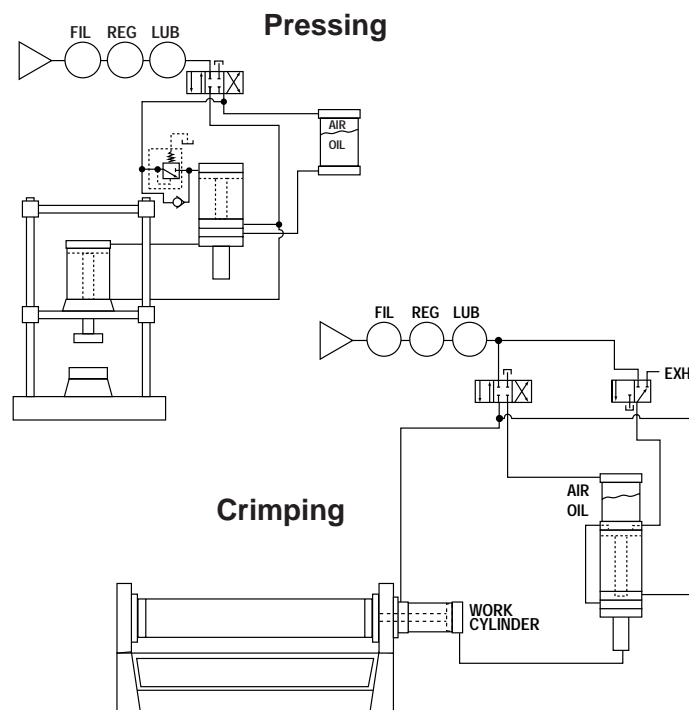

Advantages of Boosters

Boosters are an economical method of converting large volume at low pressure to small volume at high pressure. They permit you to keep high pressures within short lines near the work cylinders. Hydro-Line boosters can help reduce both initial equipment costs and operating expense.

Lower Initial Cost

Boosters eliminate the need for pumps and their associated components; permit the use of lower cost control valves; and dual-pressure booster circuits require only a fraction of the air consumed by direct air actuation.

Lower Energy Cost

Boosters hold pressure indefinitely without the loss of energy. Unless relatively expensive variable-volume pumps are used, pumping units waste power and generate heat while maintaining pressure in a holding application.

Save Space

Boosters normally can be mounted directly onto a machine. Pumping units, on the other hand, usually are bulky and require separate mounting.

Smoother Power

Though usually air-actuated themselves, boosters give work cylinders the smooth, powerful, controlled motion of hydraulics.

Safe

Boosters can be completely air-operated to function safely in any environment.

See distributor for valves.

How to Select a Booster and Air/Oil Tanks

Application Information

- A. Total work cylinder stroke
 - 1. Low-pressure advance stroke and force
 - 2. High-pressure stroke and force
 - 3. Return stroke force
- B. Available input pressure, air or liquid
- C. Speed of operation required
- D. Length of high-pressure piping to be used

Work Cylinder Selection

Work cylinder bore size depends on forces required and booster input and output pressure. Specify "air-oil" N5 series cylinders (Reference N5 Catalog).

High-Pressure Fluid Volume Required

Multiply the work cylinder piston area in square inches times the length of stroke in inches over which high pressure is required. Make allowance for compression of high-pressure fluid by adding 1% of the total volume of oil compressed for each 1000 psi of pressure. The total volume includes that of the high-pressure piping.

Booster Sizing

Determine the booster ratio for your application. This is the ratio of the available input pressure and the output operating pressure required for the application.

$$\text{Booster Ratio} = \frac{\text{Output Pressure}}{\text{Input Pressure}}$$

Determine booster stroke:

For 20 Series boosters, use the formula:

$$\text{Booster Stroke} = \frac{V + Vc}{Ar}$$

For 30 Series boosters, use the formula:

$$\text{Booster Stroke} = \frac{Vh + Vc + 2''*}{Ar}$$

Where **V** = work cylinder volume or test vessel fluid requirements in cubic inches. **Vh** = oil volume in cubic inches required to move the work cylinder piston through its high-pressure stroke. **Vc** = compressibility allowance of 1% per 1000 psi of total volume in cubic inches of oil in the high-pressure circuit. **Ar** = area of booster ram in square inches. ***+2''** = additional stroke length required to actuate high-pressure seal.

The Booster Selection Chart on page 7 shows pressure ratios and usable high-pressure volumes for both 20 and 30 Series boosters.

Sizing the Air/Oil Tank

1. Determine the volume of fluid displaced by the work cylinder by multiplying stroke by piston area.
2. Refer to Table 12-1 to find the bore and length equal to or greater than this volume. In general, longer tanks of smaller bore size are most economical.
3. Suggested minimum internal length is 6".
4. Tank should be sized so that the oil level does not change more than 6" per second.
5. Selection should be based on economics, envelope dimensions and port size in high-speed applications.
6. Air/oil tanks should be mounted vertically at the highest point in the system to allow self-bleeding of the tank.

Speed of Operation

Check to see that the air/oil port size will give adequate speed. For example, at a fluid speed of 10 feet per second, the 3/4" NPT piping will pass 63.9 cu. in. per second. (See Pressure-Thrust-Consumption-Flow Charts, Reference Catalog N5, page 19.) If the input medium is air, assume that the driving piston will move at one foot per second.

Example: Booster and Air/Oil Tank Selection

Application Information

- A. A 10" total working stroke
 - 300 lbs. of force required for the first 9 1/2"; 8000 lbs. of force required for the last 1/2"; 300 lbs. of force required for the return stroke.
- B. 80 psi air available
- C. Two seconds are available for each extending and retracting stroke
- D. 20" of high-pressure piping to be used

Work Cylinder Selection

Using the Hydro-Line slide chart, we find that a 2 1/2" bore cylinder with a 1" rod, operating on 80 psi will give 393 lbs. of force advancing and 330 lbs. of force retracting. Using the Booster Selection Chart on page 7, we find the 5" bore booster with 1" ram diameter which gives 2025 psi output with 80 psi air input. At 2025 psi, a 2 1/2" bore cylinder will produce enough force to satisfy the 8000 lbs. of force requirement. Specify Series N5 air/oil cylinder.

High-Pressure Fluid Volume Required

Volume of cylinder:

$$10'' \text{ stroke} \times 4.909 \text{ sq. in. piston area} = 49.09 \text{ cu. in.}$$

Volume of high-pressure piping (3/4"): +

This is the standard size NPT port for the 2 1/2" bore N5 air/oil cylinder.

$$20'' \text{ length} \times .533 \text{ sq. in. internal area} = 10.66 \text{ cu. in.}$$

(.533 figure is from Pipe Size Chart for Hydraulic Cylinders and Systems – N5 Catalog, pg. 19)

$$\text{Total volume of compressed oil} = 59.75 \text{ cu. in.}$$

Booster Volume Required

Booster volume for compression of oil:

(1% per 1000 psi of compression)

$$.01 \times 2.025 \text{ thousands} \times 59.75 \text{ cu. in.} = 1.21 \text{ cu. in.}$$

Booster volume for high-pressure stroke: +

$$4.909 \text{ sq. in.} \times 1/2'' \text{ stroke} = 2.45 \text{ cu. in.}$$

$$\text{Total booster volume required} = 3.66 \text{ cu. in.}$$

Booster Size

See Booster Selection Chart on page 7. Total high-pressure volume required is 3.66 cu. in. Since 3.14 cu. in. does not exceed this, but 3.93 cu. in. does, the 7" stroke booster may be used.

Air/Oil Tank Size

See Air/Oil Tank Capacity Chart on page 12. Work cylinder volume is 4.909 sq. in. of piston area x 9 1/2" of stroke = 46.64 cu. in. The air/oil tank of 6" internal height has a usable capacity of 57.3 cu. in., so it should be used.

Speed of Operation

Keep oil velocity at 10 feet per second or lower in the booster system. An air/oil tank with 3/4" NPT outlet ports will pass 63.9 cu. in. per second at 10 feet per second oil speed in piping (.533 sq. in. x 10 f.p.s. x 12" ft. = 63.96 cu. in./sec.). With 46.64 cu. in. of oil passing at 63.9 cu. in. per second, the low-pressure advance will take .73 seconds (46.64 ÷ 63.9 = .73 sec.). In addition, the high-pressure stroke will take less than 1 second. The retracting stroke will be faster because the piston rod makes part of the volume required in retracting. Porting is therefore suitable for the 2 seconds stroke time.

Booster Selection Chart

Output Pressures based on 80 psi input

Ram Dia. and Area	Stroke	Usable Volume (cu. in.)		5" Bore Ratio & Pressure Output	6" Bore Ratio & Pressure Output	8" Bore Ratio & Pressure Output	10" Bore Ratio & Pressure Output	12" Bore Ratio & Pressure Output	14" Bore Ratio & Pressure Output
		Series 20	Series 30						
5/8" .3068 sq. in.	6	1.84	1.23	64.80:1 ratio gives 5184 psi output					
	7	2.15	1.53						
	8	2.45	1.84						
	9	2.76	2.15						
	10	3.07	2.45						
	11	3.37	2.76						
1" .7854 sq. in.	6	4.71	3.14	25.31:1 ratio gives 2025 psi output	36.38:1 ratio gives 2910 psi output	64.50:1 ratio gives 5160 psi output			
	7	5.50	3.93						
	8	6.28	4.71						
	9	7.07	5.50						
	10	7.85	6.28						
	11	8.64	7.07						
1 3/8" 1.4849 sq. in.	6	8.91	5.94	13.39:1 ratio gives 1071.1 psi output	19.24:1 ratio gives 1539.2 psi output	34.12:1 ratio gives 2729.3 psi output	53.22:1 ratio gives 4257.8 psi output		
	7	10.39	7.42						
	8	11.88	8.91						
	9	13.36	10.31						
	10	14.85	11.88						
	11	16.33	13.36						
1 3/4" 2.4053 sq. in.	6	14.43	9.62	8.27:1 ratio gives 661.4 psi output	11.88:1 ratio gives 950.2 psi output	21.06:1 ratio gives 1648.9 psi output	32.86:1 ratio gives 2628.6 psi output	47.27:1 ratio gives 3781.2 psi output	
	7	16.84	12.03						
	8	19.24	14.43						
	9	21.65	16.84						
	10	24.05	19.24						
	11	26.46	21.65						
2" 3.1416 sq. in.	6	18.85	12.57	6.33:1 ratio gives 506.2 psi output	9.09:1 ratio gives 727.5 psi output	16.13:1 ratio gives 1290 psi output	25.16:1 ratio gives 2012.5 psi output	36.19:1 ratio gives 2895.1 psi output	49.22:1 ratio gives 3937.6 psi output
	7	21.99	15.71						
	8	25.13	18.85						
	9	28.27	21.99						
	10	31.42	25.13						
	11	34.56	28.27						
2 1/2" 4.9087 sq. in.	6	29.45	19.63	4.05:1 ratio gives 324 psi output	5.82:1 ratio gives 465.6 psi output	10.32:1 ratio gives 825.6 psi output	16.10:1 ratio gives 1288 psi output	23.16:1 ratio gives 1852.8 psi output	31.5:1 ratio gives 2520.1 psi output
	7	34.36	24.54						
	8	39.27	29.45						
	9	44.18	34.36						
	10	49.09	39.27						
	11	54.00	44.18						
3" 7.0686 sq. in.	6	42.41	28.27	2.81:1 ratio gives 225 psi output	4.04:1 ratio gives 323.4 psi output	7.17:1 ratio gives 573.4 psi output	11.18:1 ratio gives 894.5 psi output	16.08:1 ratio gives 1286.7 psi output	21.88:1 ratio gives 1750.1 psi output
	7	49.48	35.34						
	8	56.55	42.41						
	9	63.62	49.48						
	10	70.69	56.55						
	11	77.75	63.62						
	12	84.82	70.69						

For larger usable volume requirements, longer strokes are available. Limit output pressures to 5000 psi for standard boosters. Limit input pressures to the maximum operating pressures for Series R5 cylinders. For higher output pressures, contact Hydro-Line for a custom booster.

How to Order a Booster

Hydro-Line standard boosters can be completely and accurately identified with a model number that encodes construction specifications. To develop the model number for ordering a booster, see following example:

Feature	Description	Symbol	
Ram Diameter	Specify in inches (2 position decimal)	—	
Cushions	Non-cushioned	N	
	Cushioned cap end	C	
Stroke	Specify in inches (2 position decimal)	—	
Bore	Specify in inches (2 position decimal)	—	
Reciprocating	Include ONLY for reciprocating boosters	D	
Mounting Style	Side lugs	A	
	Side tapped	B	
	No mount	K	
	All tie rods extended	L	
	Head end tie rods extended	M	
	Cap end tie rods extended	N	
	Angle Mount	Y	
	Special – Non-standard Mount	X	
Model/Series	Series 30	30	
	Series 20	20	
Ports	NPTF	N	
	SAE	S	
	Special	X	
Ram Seals	PolyPak	P	
	Special	X	
Piston Seals	Nitrile lip-type	N	
	Special	X	
Special Modifications	Include ONLY if special modifications are required.		
	Air bleeders	Spring return	X
	Drainbacks	Special paint/plating	
	Bronze bushings	Special port locations	
	Stainless steel ram	Indicator switches	
	Integral tank		
	Port or cushion modifications		

HOW TO ORDER

- Quantity
- Model Number
- Special modifications if required
- Completed Application Data Sheet(s) if required
- Required ship date

30AD 5.00 X 4.00 - N - 1.00

N - P - N - X



HYDRO-LINE, INC.
Rockford, IL

30AD 5.00 X 4.00 - N - 1.00
- N - P - N - X
195011234-1
A115790-375

Customer Number (if desired)
Hydro-Line Serial Number



National
FLUID POWER
Association

Series 30

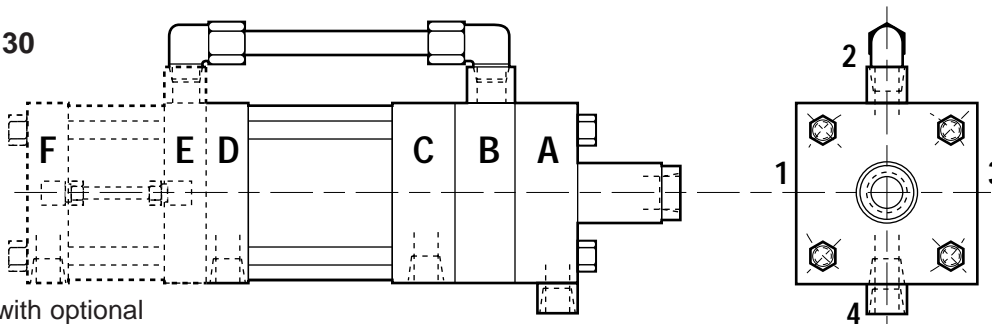

Shown with optional integrally mounted tank (Piping not included)

Standard ports and locations as shown. If special ports and/or locations are required, specify when ordering.

Series 20

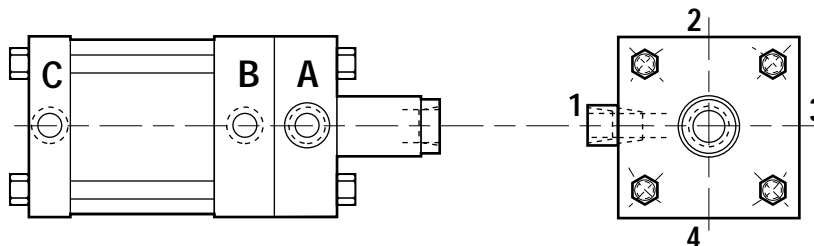

Hydro-Line Application Data Sheet

Company Name: _____	Distributor Name: _____
Contact: _____	Contact: _____
Phone Number: _____ Fax Number: _____	Phone Number: _____ Fax Number: _____

QUANTITY <input style="width: 20px; height: 20px;" type="text"/> <input style="width: 20px; height: 20px;" type="text"/> <input style="width: 20px; height: 20px;" type="text"/> <input style="width: 20px; height: 20px;" type="text"/>	MODEL NUMBERING SYSTEM
MODEL/SERIES MOUNT BORE STROKE CUSHION ROD DIA. ROD STY PORTS SEALS PORT LOC H C MOD.	
<input style="width: 100%; height: 20px;" type="text"/>	
DOUBLE END ADDITIONAL ROD LENGTH NEEDLE LOCATION KEYPLATE 4-FLAT BLEEDERS BRONZE BUSHING DRAIN-BACK IND.SWITCH MODEL PREFIX ROD STYLE HEAD CAP HEAD CAP HEAD CAP	
<input style="width: 100%; height: 20px;" type="text"/>	
STOP TUBE LENGTH TRUNNION XI DIMENSION STAINLESS STEEL ROD TYPE	
<input style="width: 100%; height: 20px;" type="text"/>	

Please fill in all available information above. Refer to the Hydro-Line Model Numbering System on Pages 7 & 8.

WHAT IS THE OPERATING ENVIRONMENT? <u>Fluid Media Operating Pressure</u> Air _____ Minimum _____ P.S.I. Oil _____ Typical _____ P.S.I. Other _____ Maximum _____ P.S.I. Fluid Type _____	WHAT IS THE WORK BEING PERFORMED? <u>Load</u> <u>Rod Speed</u> <u>Cycles per minute</u> Push _____ lbs. Extend _____ Inches/second Pull _____ lbs. Retract _____ Inches/second _____ (in and out)
<u>Temperature at Cylinder</u> Minimum _____ °F Typical _____ °F Maximum _____ °F	

WHAT IS THE MOUNTING?			
Attitude	Angle	Rod End Connection	Known Side Load
Vertical _____	Horizontal _____	Firmly Guided _____	_____ lbs.
Rod Up _____	Degrees From Vertical _____	Supported _____	
Rod Down _____	Rod Up _____	Unsupported _____	
	Rod Down _____		

WHAT ENVIRONMENTAL CONDITIONS IS THE CYLINDER SUBJECTED TO?

Standard Factory _____ Corrosive Washdown _____ Chemical? _____ Outdoors _____ Other _____

WHAT IS THE PRESENT CYLINDER TYPE AND MODEL NUMBER?

WHAT IS THE PRESENT PROBLEM?

WHAT INDUSTRY IS THE CYLINDER USED IN?	WHAT TYPE OF MACHINE IS THE CYLINDER USED ON?	WHAT IS THE CYLINDER NAME USED IN THE APPLICATION?

APPLICATION SKETCH: <div style="height: 150px; border: 1px solid black;"></div>	DESCRIPTION OF APPLICATION OR SPECIAL REQUIREMENT: <div style="height: 150px; border: 1px solid black;"></div>
---	--

PREPARED BY:	DATE:	REVIEWED BY:	DATE:
CUSTOMER DRAWING NUMBER:	REVISION DATES:		QUOTE NUMBER:

Series 30 Booster Mounting Dimensions

Dimension Chart

Bore Size	3/4	4	5	6	8	10	12	14
AA	3.9	4.7	5.8	6.9	9.1	11.2	13.3	15.4
AB	7/16	7/16	9/16	9/16	11/16	13/16	13/16	15/16
AL	1 1/4	1 1/4	1 3/8	1 3/8	1 13/16	2 1/8	2 1/8	2 7/16
AO	1/2	1/2	5/8	5/8	11/16	7/8	7/8	1 1/16
AT	1/8	1/8	3/16	3/16	1/4	3/8	3/8	3/8
BA	7 3/4	7 3/4	8	9	9 1/18	10 7/8	11 3/8	13 5/8
BB	13/8	13/8	1 13/16	1 13/16	2 5/16	2 11/16	2 11/16	3 3/16
BE	1 1/16	1 1/16	1 1/16	1 3/16	1 3/16	1	1	1 13/16
BF	13/16	13/16	13/16	15/16	15/16	1 1/8	1 1/8	1 1/4
DD	3/8-24	3/8-24	1/2-20	1/2-20	5/8-18	3/4-16	3/4-16	7/8-14
E	3 3/4	4 1/2	5 1/2	6 1/2	8 1/2	10 5/8	12 3/4	14 3/4
EE(1) NPTF	1/2	1/2	1/2	3/4	3/4	1	1	1 1/4
EE(2) NPTF	3/4	3/4	3/4	1	1	1 1/4	1 1/4	1 1/2
EF	1	1	1	1 3/16	1 3/16	1 5/16	1 5/16	1 9/16
EG	2 13/16	2 13/16	2 13/16	3 3/8	3 3/8	4 3/16	4 3/16	4 13/16
G	1 3/4	1 3/4	1 3/4	2	2	2 1/4	2 1/4	2 3/4
J	1 1/4	1 1/4	1 1/4	1 1/2	1 1/2	2	2	2 1/4
K	3/8	3/8	7/16	7/16	9/16	1 1/16	1 1/16	1 3/16
NT	1/2-13	1/2-13	5/8-11	3/4-10	3/4-10	1-8	1-8	1 1/4-7
R	2.76	3.32	4.10	4.88	6.44	7.92	9.40	10.90
SB	9/16	9/16	13/16	13/16	13/16	1 1/16	1 1/16	1 5/16
SN	2 5/8	2 5/8	2 7/8	3 1/8	3 1/4	4 1/8	4 5/8	5 1/2
SS	3 1/4	3 1/4	3 1/8	3 5/8	3 3/4	4 5/8	5 1/8	5 7/8
ST	3/4	3/4	1	1	1	1 1/4	1 1/4	1 1/2
SU	1 1/4	1 1/4	1 9/16	1 9/16	1 9/16	2	2	2 1/2
SW	1/2	1/2	1 1/16	1 1/16	1 1/16	7/8	7/8	1 1/8
SX	1 1/16	1 1/16	1 1/16	1 3/16	1 3/16	1	1	1 3/16
TK	3/4	3/4	1	1 1/8	1 1/8	1 1/2	1 1/2	1 7/8
TN	1 1/2	2 1/16	2 11/16	3 1/4	4 1/2	5 1/2	7 1/4	8 3/8
TS	4 3/4	5 1/2	6 7/8	7 7/8	9 7/8	12 3/8	14 1/2	17
US	5 3/4	6 1/2	8 1/4	9 1/4	11 1/4	14 1/8	16 1/4	19 1/4

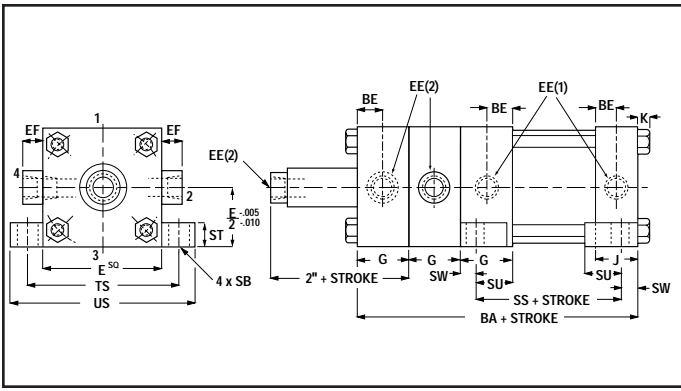

30A – Side Lugs Mount

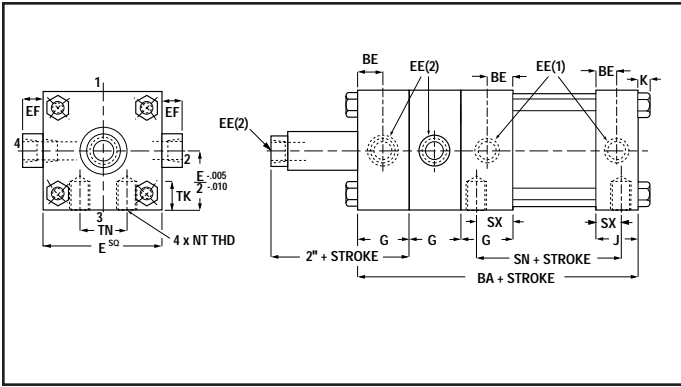

30B – Side Tapped Mount

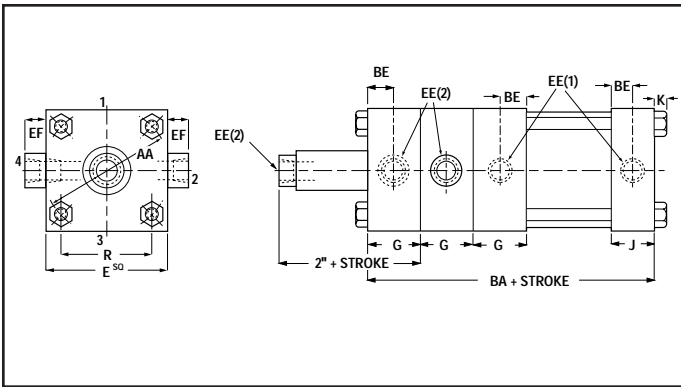

30K – No Mount

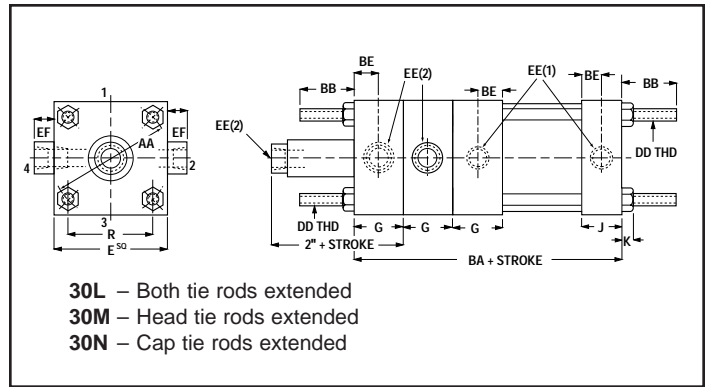

30L, M & N – Tie Rods Extended Mount

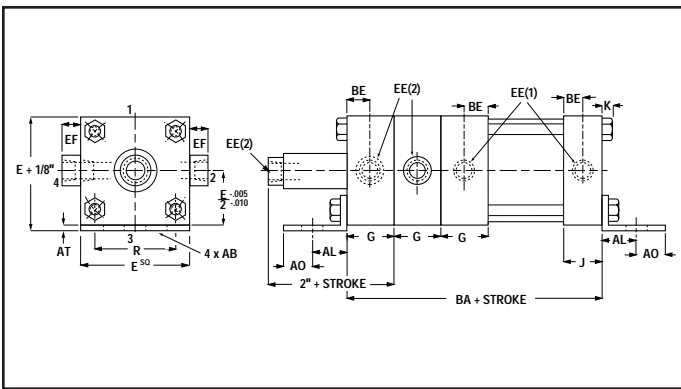

30Y – Angle Mount

Series 20 Booster Mounting Dimensions

Dimension Chart

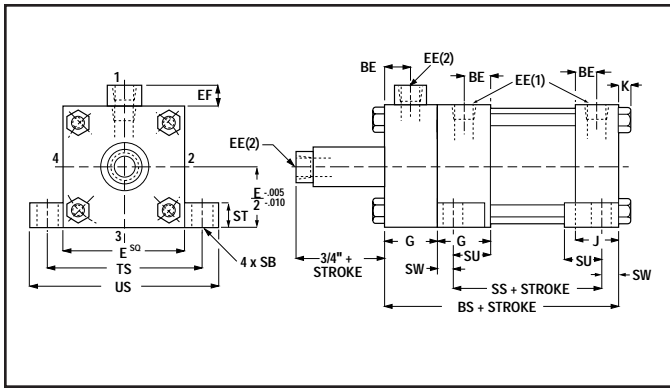

20A – Side Lugs Mount

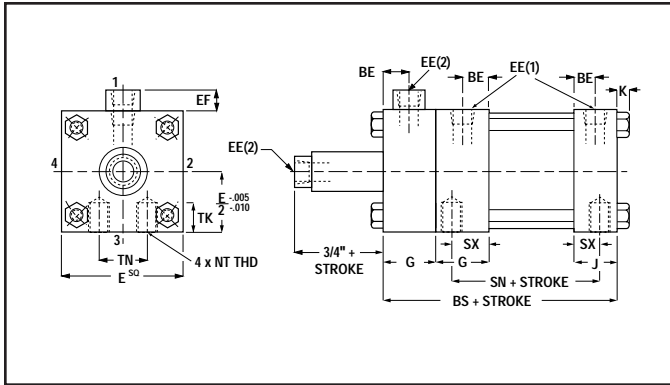

20B – Side Tapped Mount

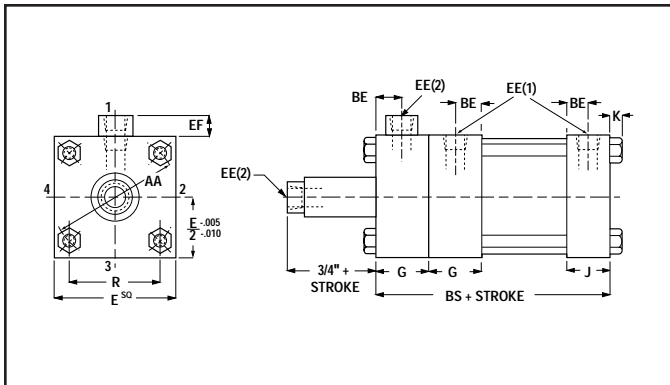

20K – No Mount

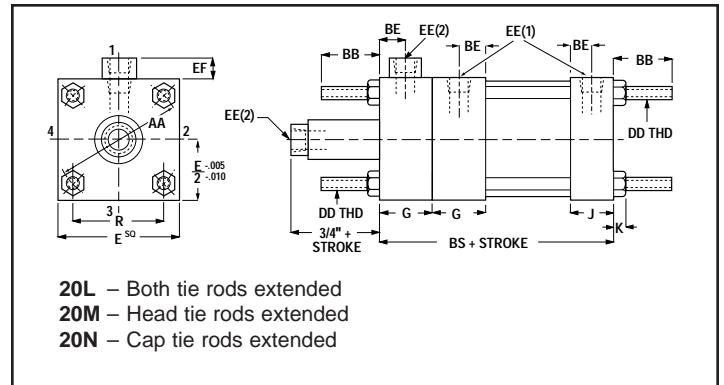

20L, M & N – Tie Rods Extended Mount

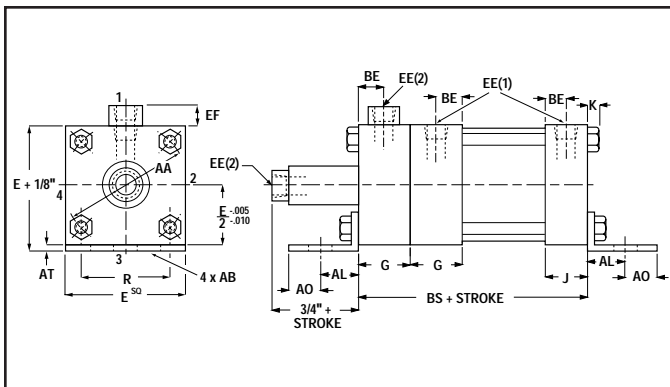

20Y – Angle Mount

Bore Size	3/4	4	5	6	8	10	12	14
AA	3.9	4.7	5.8	6.9	9.1	11.2	13.3	15.4
AB	7/16	7/16	9/16	9/16	11/16	13/16	13/16	15/16
AL	1 1/4	1 1/4	1 3/8	1 3/8	1 13/16	2 1/8	2 1/8	2 7/16
AO	1/2	1/2	5/8	5/8	11/16	7/8	7/8	1 1/16
AT	1/8	1/8	3/16	3/16	1/4	3/8	3/8	3/8
BB	1 3/8	1 3/8	1 13/16	1 13/16	2 5/16	2 11/16	2 11/16	3 3/16
BE	1 1/16	1 1/16	1 1/16	1 3/16	1 3/16	1	1	1 3/16
BS	6	6	6 1/4	7	7 1/8	8 5/8	9 1/8	10 7/8
DD	3/8-24	3/8-24	1/2-20	1/2-20	5/8-18	3/4-16	3/4-16	7/8-14
E	3 3/4	4 1/2	5 1/2	6 1/2	8 1/2	10 5/8	12 3/4	14 3/4
EE(1) NPTF	1/2	1/2	1/2	3/4	3/4	1	1	1 1/4
EE(2) NPTF	3/4	3/4	3/4	1	1	1 1/4	1 1/4	1 1/2
EF	1	1	1	1 3/16	1 3/16	1 5/16	1 5/16	1 9/16
G	1 3/4	1 3/4	1 3/4	2	2	2 1/4	2 1/4	2 3/4
J	1 1/4	1 1/4	1 1/4	1 1/2	1 1/2	2	2	2 1/4
K	3/8	3/8	7/16	7/16	9/16	1 1/16	1 1/16	1 3/16
R	2.76	3.32	4.10	4.88	6.44	7.92	9.40	10.90
SB	9/16	9/16	1 3/16	1 3/16	1 3/16	1 1/16	1 1/16	1 5/16
SN	2 5/8	2 5/8	2 7/8	3 1/8	3 1/4	4 1/8	4 5/8	5 1/2
SS	3 1/4	3 1/4	3 1/8	3 5/8	3 3/4	4 5/8	5 1/8	5 7/8
ST	3/4	3/4	1	1	1	1 1/4	1 1/4	1 1/2
SU	1 1/4	1 1/4	1 9/16	1 9/16	1 9/16	2	2	2 1/2
SW	1/2	1/2	1 1/16	1 1/16	1 1/16	7/8	7/8	1 1/8
SX	1 1/16	1 1/16	1 1/16	1 3/16	1 3/16	1	1	1 3/16
TK	3/4	3/4	1	1 1/8	1 1/8	1 1/2	1 1/2	1 7/8
TN	1 1/2	2 1/16	2 11/16	3 1/4	4 1/2	5 1/2	7 1/4	8 3/8
TS	4 3/4	5 1/2	6 7/8	7 7/8	9 7/8	12 3/8	14 1/2	17
US	5 3/4	6 1/2	8 1/4	9 1/4	11 1/4	14 1/8	16 1/4	19 1/4

Air/Oil Tanks

Specifications

Pressure Rating: 200 psi

Temperature: 400°F maximum

Maximum Usable Capacities – Cubic Inches

Tank Bore (inches)	Tank Length (inches)															
	6	7	8	9	10	11	12	13	14	15	16	17	18	19	20	22
3 ¹ / ₄	24.4	32.6	39.9	46.8	54.1	60.9	69.2	76.9	84.1	91.3	98.8	106	114	122	129	143
4	36.8	49.1	60.2	70.6	81.7	91.9	104	116	127	138	149	161	172	184	195	216
5	57.3	76.5	93.8	110	127	143	163	181	198	215	232	250	268	286	304	337
6	82.3	110	135	158	183	206	234	260	284	309	334	359	386	411	437	484
8	146	195	239	280	324	365	414	461	504	547	592	637	684	729	774	858
10	228	304	373	437	506	569	646	719	786	854	923	994	1067	1138	1208	1339
12	327	438	537	629	728	819	930	1035	1130	1228	1328	1430	1535	1637	1737	1926
14	445	595	730	855	990	1113	1265	1407	1537	1670	1806	1945	2088	2227	2363	2619

Air/Oil Tank Dimensions

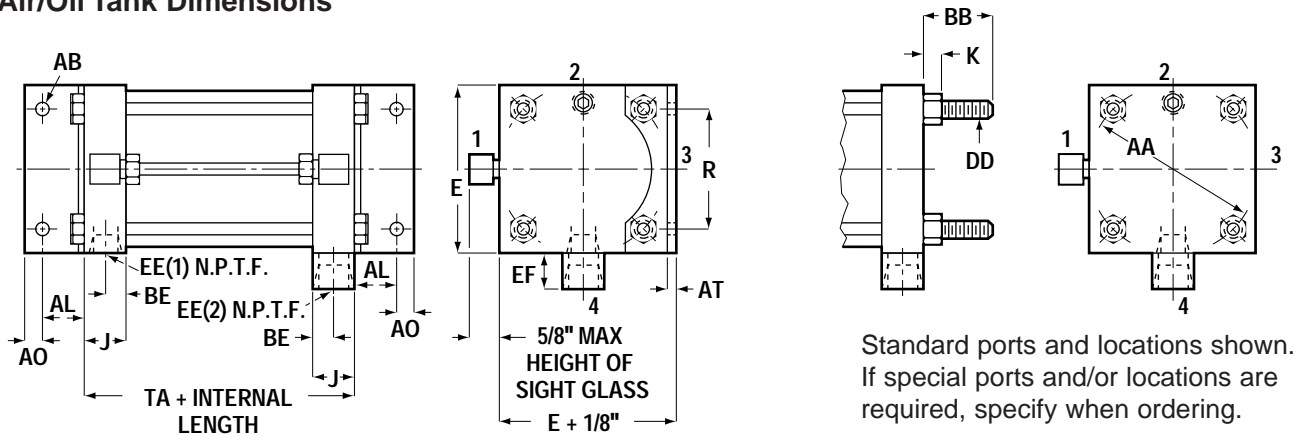

T Series Air-Oil Tank Mounting Dimensions

Bore Size	Port Area (sq. in.)	AA	AB	AL	AO	AT	BB	BE	DD	E	EE(1)	EE(2)	EF	J	K	R	TA
3 ¹ / ₄	.405	3.9	7/16	1 ¹ / ₄	1/2	1/8	13/8	11/16	3/8-24	33/4	1/2	3/4	1	1 ¹ / ₄	3/8	2.76	2 ¹ / ₂
4	.405	4.7	7/16	1 ¹ / ₄	1/2	1/8	13/8	11/16	3/8-24	4 ¹ / ₂	1/2	3/4	1	1 ¹ / ₄	3/8	3.32	2 ¹ / ₂
5	.405	5.8	9/16	13/8	5/8	3/16	113/16	11/16	1/2-20	5 ¹ / ₂	1/2	3/4	1	1 ¹ / ₄	7/16	4.10	2 ¹ / ₂
6	.667	6.9	9/16	13/8	5/8	3/16	113/16	13/16	1/2-20	6 ¹ / ₂	3/4	1	13/16	1 ¹ / ₂	7/16	4.88	3
8	.667	9.1	11/16	113/16	11/16	1/4	25/16	13/16	5/8-18	8 ¹ / ₂	3/4	1	13/16	1 ¹ / ₂	9/16	6.44	3
10	1.05	11.2	13/16	2 ¹ / ₈	7/8	3/8	211/16	1	3/4-16	10 ⁵ / ₈	1	11/4	15/16	2	11/16	7.92	4
12	1.05	13.3	13/16	2 ¹ / ₈	7/8	3/8	211/16	1	3/4-16	12 ³ / ₄	1	11/4	15/16	2	11/16	9.40	4
14	1.77	15.4	15/16	27/16	11/16	3/8	33/16	13/16	7/8-14	14 ³ / ₄	1 ¹ / ₄	1 ¹ / ₂	19/16	2 ¹ / ₄	13/16	10.90	4 ¹ / ₂

How to Order a Tank

Hydro-Line standard tanks can be completely and accurately identified with a model number that encodes construction specifications. To develop the model number for ordering a tank, see following example:

Feature	Description	Symbol
Model/Series	Air/Oil Tank	T
Mounting Style	No mount	K
	All tie rods extended	L
	Head end tie rods extended	M
	Cap and tie rods extended	N
	Angle Mount	Y
	Special	X
Bore	Specify in inches (2 position decimal)	-
Tank Length	Specify in inches (2 position decimal)	-

TY 5.00 X 6.00

HOW TO ORDER

1. Quantity
2. Model Number
3. Special modifications if required
4. Completed Application Data Sheet(s) if required
5. Required ship date



National
FLUID POWER
Association
MEMBER



HYDRO-LINE, INC.
Rockford, IL

TY 5.00 x 6.00

195011234-1

A115790-375

Customer Number (if desired)

Hydro-Line Serial Number

ONE YEAR LIMITED WARRANTY

One Year Normal Use

Hydro-Line Products are warranted for a period of one year from date of shipment from our plant to be free from defects in workmanship and material under correct use, normal operating conditions and proper applications. This warranty does not extend to goods damaged, or subjected to accident, abuse, or misuse after shipment from our factory, nor to goods altered or repaired by anyone other than authorized Hydro-Line representatives.

Disclaimers

This one year limited warranty is the only warranty extended by Hydro-Line in connection with any sale by Hydro-Line. THIS WARRANTY IS IN LIEU OF ALL OTHER WARRANTIES, EXPRESS OR IMPLIED, INCLUDING WARRANTIES OF MERCHANTABILITY AND FITNESS FOR A PARTICULAR PURPOSE, notwithstanding disclosure to Hydro-Line of the product's intended use. An affirmation of fact or promise made on behalf of Hydro-Line shall not be deemed to create an express warranty that the goods shall conform to the affirmation of promise; any description of the goods is for the sole purpose of identifying them and shall not be deemed to create an express warranty that the goods shall conform to such description; any sample or model is for illustrative purposes only and shall not be deemed to create an express warranty that the goods shall conform to the sample or model; and no affirmation or promise, or description, or sample or model, shall be deemed part of the basis of the bargain.

Exclusive Remedy

Hydro-Line's obligation upon breach of warranty shall be limited to replacing or repairing at our option, free of

charge, but not including installation, dismantling, reassembling or any other charge, the particular product or part which inspection discloses to have been defective at time of shipment. Inspection may be at the place of installation and use, or at our plant if requested (if returned to us at our expense including lowest transportation cost). Written notice of such defect shall be given by customer to Hydro-Line within 30 days after such defect(s) appear. Written permission for any warranty claim return must be first obtained from authorized Hydro-Line representatives. All returns must be accompanied with a complete written explanation of claimed defects and the circumstances of operational failure. Replacement of cylinders or parts thereof repaired under this warranty shall be warranted under the terms of this warranty for the remainder of the term of the original warranty or for a period of six months after such repair or replacement, whichever is longer. Upon expiration of the warranty, all of Hydro-Line's obligations hereunder shall terminate.

IN NO EVENT SHALL HYDRO-LINE HAVE ANY LIABILITY FOR PAYMENT OF ANY CONSEQUENTIAL, INCIDENTAL, INDIRECT, SPECIAL OR TORT DAMAGES OF ANY KIND INCLUDING, BUT NOT LIMITED TO, ANY LOSS OF PROFITS, TO THE EXTENT EXCLUSION IS PERMITTED BY LAW.

This warranty states our entire and exclusive liability and buyer's exclusive remedy for any claim of damages in connection with the sale or furnishing of Hydro-Line's products or parts, their design, suitability for use, installations or operation, or for any claimed defects therein. Goods not manufactured by Hydro-Line are furnished subject only to the Manufacturer's warranties, if any, and without warranties, express or implied, by Hydro-Line.

HYDRO-LINE Actuation Products



N5 SERIES CYLINDERS

- NFPA interchangeable
- **N5** – 3000 psi nominal hydraulic
- **AN5** – to 250 psi very heavy-duty pneumatic
- **LAN5** – to 250 psi very heavy-duty pneumatic – permanently lubricated
- All steel construction



R5 SERIES CYLINDERS

- NFPA interchangeable
- **A5/R5** – to 250 psi pneumatic
- **LA5/LR5** – to 250 psi pneumatic – permanently lubricated
- **HA5** – to 400 psi hydraulic
- **HR5** – 1500 psi nominal hydraulic



Q5 SERIES CYLINDERS

- NFPA interchangeable
- **Q5** – to 250 psi pneumatic
- **LQ5** – to 250 psi pneumatic – permanently lubricated
- **HQ5** – to 400 psi hydraulic
- Aluminum construction



HM SERIES CYLINDERS

- Conform to international metric specifications ISO 6020/2 and DIN 24 554
- 25 mm to 200 mm bore sizes
- 210 BAR nominal hydraulic
- All steel construction



ROCKFORD SERIES CYLINDERS

- ASAE interchangeable agricultural cylinders
- **Rockford 2500**–2500 psi hydraulic
- **Rockford 3000**–3000 psi hydraulic



ELECTRONIC FEEDBACK CYLINDERS

Hydraulic or pneumatic cylinders which incorporate cylinder position sensing and feedback throughout the stroke. Available in N5, R5, A5, Q5, HM, HW, SM or special cylinders.



SERIES 20/30 BOOSTERS

- Standard series to 5000 psi output
- Custom designs to 20,000 psi

T SERIES AIR/OIL TANKS

- All steel construction

QT SERIES AIR/OIL TANKS

- Aluminum end caps and translucent tubing



V5 SERIES CYLINDERS

- NFPA Interchangeable
- To 200 psi pneumatic
- Aluminum construction
- Now available in 5", 6" and 8" bore



HW SERIES CYLINDERS

- Welded construction
- 3000 psi nominal hydraulic



TSAYER CYLINDERS

- Threaded body construction
- To 200 psi pneumatic
- To 1000 psi nominal hydraulic



SM SERIES CYLINDERS

- Steel mill type construction
- **MSM**–2000 psi nominal hydraulic
- **HSM**–3000 psi nominal hydraulic
- **ASM**–Pneumatic



CUSTOM CYLINDERS

Custom cylinders to meet special requirements

- Bores to 48"
- Strokes to 300"
- Pressures to 10,000 psi or higher



VISIT OUR WEB SITE:
www.hydro-line.com

830 MEREDITH WAY
SPARKS, NEVADA 89431 U.S.A.
702-355-7071 • FAX 702-355-7170

HIGHWAY 20 WEST • P.O. BOX 2068
DECATUR, ALABAMA 35602 U.S.A.
205-350-2603 • FAX 205-351-1264

HYDRO-LINE s.r.l.
VIA CAPRETTI 12/14
1-25136 STOCCHETTA BS, ITALY
(39)-030-201-6211 • (39)-030-209-1500

HEADQUARTERS

4950 MARLIN DRIVE • P.O. BOX 2045
ROCKFORD, ILLINOIS 61130 U.S.A.
815-654-9050 • FAX 815-654-3393

4908 HOVIS ROAD
CHARLOTTE, NORTH CAROLINA 28208 U.S.A.
704-394-0043 • FAX 704-394-0073

PATRICK GREGORY ROAD
WOLVERHAMPTON WEST MIDLANDS, WV11 3DZ U.K.
(0) 1902 304000 • FAX (0) 1902 305676

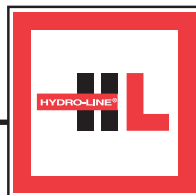

HYDRO-LINE, INC.

An IMC Company

Delivering Engineered Solutions
in Actuation Worldwide